



Cordless Riveter

R2B1

Instruction Manual

Table of Contents

Introduction	2
Safety Precautions	3
Names of Components	10
Specifications	12
Preparation before Use	13
Procedures for Charging	16
Procedures for Work	18
Points of Maintenance and Inspection	22
Storage	27
Parts Table	28
How to Order Parts	30
Troubleshooting	30

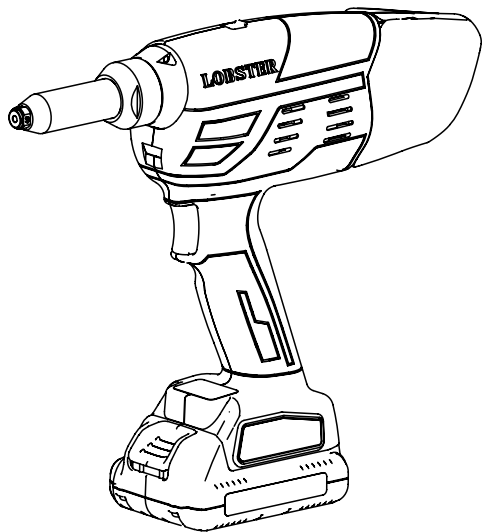

This machine is a dedicated tool for blind rivet for professional use.

Thank you for purchasing the LOBSTER brand cordless riveter.

- Before using this machine, thoroughly read this instruction manual to ensure proper operation.
- After reading this instruction manual, keep it safe.
- When this machine becomes inoperable, refer to “Troubleshooting (page 30).”
- Note that the contents of this manual are subject to change without prior notice for improvement.
- Unauthorized publication, duplication, and translation of this instruction manual, in part or in whole, is prohibited.

LOBTEX CO.,LTD.

Call center Tel: +81-72-980-1111 Fax: +81-72-980-1166

12-8 Shijo-cho, Higashi-Osaka City, Osaka

Website <https://www.lobtex.co.jp/>

579-8053, Japan

No .RCR2B1S02005

● Introduction

Thank you for purchasing the LOBSTER brand cordless riveter.
(hereinafter referred to as “this machine”)

- This machine is dedicated tool for blind rivet used to calk and tighten the LOBSTER brand rivets. This machine is not designed, manufactured, or sold for other usages.
- This instruction manual (hereinafter referred to as “this document”) contains the correct operation, maintenance, and inspection methods for safely and efficiently using this machine, as well as product information.
- Use rivets with the specifications and strength for which you have fully conducted design discussion.

1 Important notes

- Before handling this machine, be sure to thoroughly read this document. For handling of this machine and replacement of accessories and parts, observe the instructions in this document.
- If you have any questions about the contents of this document, contact the store where you purchased this machine or our call center.
- It is not possible to foresee all the potential hazards and describe them in this document.
When handling this machine, pay careful attention not only to the matters described in this document, but also to safety measures.
- The original language of this document is Japanese.
Fully understand the contents of this document on your own responsibility.
- This document is copyrighted by LOBTEX CO., LTD. Unauthorized publication, duplication, reproduction, and translation into other language of this instruction manual are prohibited.

2 Disclaimer

- We will not compensate for damage and profit loss directly or indirectly caused by misuse, abuse, unauthorized modification, etc. of this machine, nor guarantee the rivet including its strength.
- We will not be held liable in any way for any damage or problem caused by modification that is not approved by us in written form.
- We will not be held liable in any way for any damage or problem caused by use of parts other than the recommended parts.

Revision history of instruction manual	
Product name:	Cordless riveter
	model R2B1
First edition issuance date:	June 2020
5th edition issuance date:	Feb. 2025

● Safety Precautions



◆ Before using this machine, read all “Safety Precautions” below to fully understand them for the correct and safe use of this machine.



◆ During use of this machine, be sure to wear protective goggles. Failure to follow this instruction may cause you to get injured when the mandrel of a cut rivet springs out.

◆ The precautions listed here are divided into **⚠ WARNING** and **⚠ CAUTION** and their respective meanings are as shown below.

⚠ WARNING: Indicates a potentially hazardous situation, which, if this machine is handled improperly, could result in death or serious injury of the user.

⚠ CAUTION: Indicates a potentially hazardous situation, which, if this machine is handled improperly, could result in injury of the user or property damage only.

Note that even a matter categorized as **⚠ CAUTION** may lead to a serious consequence. As instructions in both categories describe important matters, be sure to observe all the safety precautions.

◆ After reading this document, be sure to keep it at hand so that the user can refer to it anytime.

⚠ WARNING



Compulsory

1. During battery charging, if the charging is not completed even when the specified charging time has passed, stop charging.

- Consult the store where you purchased this machine or us. If charging is continued in this condition, an accident or injury may result.

2. If you have observed an abnormality of the battery pack, including an abnormal odor, heat generation, discoloration, and deformation, immediately stop the machine and take out the battery pack from this machine or charger.

- Consult the store where you purchased this machine or us. If you continue the use of this machine in this condition, an accident or injury may result.

3. Use this machine by connecting it to a power source with an indication of the rating.

- Do not use this machine by connecting it to a direct current source, an engine power generator, or a transformer or similar device such as potential transformer and booster. Failure to follow this instruction may cause abnormal heat generation and fire.

4. Charge the battery pack at a well-ventilated location.

- Do not cover the battery pack or charger with cloth or the like during charging. Failure to follow this instruction may cause heat generation, smoke, and fire.

⚠ WARNING

5. If an abnormality such as smoke and an abnormal odor has occurred during use of the charger, immediately stop using it and disconnect the power plug from the receptacle.

- Consult the store where you purchased this machine or us. Use of the charger in this condition may cause an accident or injury.

6. If the battery liquid leaks out or abnormal odor is produced, immediately stop using the machine and keep the battery away from fire.

- Consult the store where you purchased this machine or us. Use of the battery in this condition may cause an accident or injury.

7. Carefully handle the battery pack and charger.

- Do not drop the battery pack and charger, and do not give a strong shock to them. If the outer case is broken, do not use the battery pack or charger. Failure to follow this instruction may cause an electric shock, smoke, fire, bursting, or other accident.
- Do not disassemble or modify the battery pack and charger. Failure to follow this instruction may cause an electric shock, smoke, fire, bursting, or other accident.
- Failure to follow this instruction may cause an accident or injury.

8. If the battery liquid has leaked out, do not touch it with bare hands, but take the following actions.

- If the battery liquid gets into your eye, you could become visually impaired in one eye.
In this case, do not rub your eye, but wash it immediately with clean water and then consult a doctor.
- If the battery liquid gets on your body or cloth, skin inflammation or injury may be caused. Sufficiently wash the liquid away with clean water and then consult a doctor.
- Stop using a battery pack from which the battery liquid has leaked out, and do not put it close to fire. Immediately consult the store where you purchased this machine.

9. Positively insert the power plug all the way.

- If insertion is insufficient, an electric shock or heat generation may cause fire. Do not use a damaged plug and a loose receptacle.

10. If an abnormality, such as malfunctioning, heat generation, smoke, or abnormal sound is observed during use, immediately take out the battery pack and stop using this machine.

- Consult the store where you purchased this machine or us.
Use of the battery in this condition may cause an accident or injury.

11. Use dedicated genuine parts only.

- Do not use parts other than the genuine parts that are listed in this document and our catalogues.
Failure to follow this instruction may cause a serious accident or injury.

12. Take into consideration the circumstances surrounding the workshop as well.

- This prevents accidents and injuries.

13. Ensure the workshop is sufficiently lit.

- Work in a dark location may cause an accident or injury.



Compulsory

WARNING



- 14. Always wear personal protective equipment and protective goggles.**
 - Appropriately use a dust protective mask, safety shoes, a helmet, earpieces, and others to prevent an accident or injury.
- 15. In replacement of a part or accessory, follow the specified procedures.**
 - If the specified procedures are not followed, a failure, an accident, or injury may occur.
- 16. Do not make inadvertent actions. When you are not working, do not touch the trigger switch with your finger or an object.**
 - Do not carry this machine by hooking your finger to a trigger switch.
 - Failure to follow this instruction may cause this machine to unexpectedly start, possibly leading to an accident or injury.
- 17. When you do not use this machine or a risk is anticipated, turn off the switch on this machine and take out the battery pack from the machine body.**
 - Failure to follow this instruction may lead to an accident or injury when an unexpected action is made.
- 18. When conducting maintenance, inspection and part replacement, be sure to take out the battery pack.**
 - Failure to follow this instruction may lead to an accident or injury when an unexpected action is made.
- 19. If two or more battery packs are used in succession, stop this machine for about 15 minutes.**
 - Failure to follow this instruction may cause the temperature of the machine body to excessively rise, possibly leading to burns.



- 20. Do not charge the battery pack at an ambient temperature outside the charger operation temperature range.**
 - Failure to follow this instruction may disable correct charging and shorten the service life of the battery pack. Heat generation, smoke, fire, bursting, or other accident may also be caused.
- 21. Do not use a deteriorated battery pack.**
 - Failure to follow this instruction may cause battery liquid leakage, electric shock, heat generation, smoke, fire, bursting, or other accident.
- 22. Do not immerse the battery pack in conductive liquid such as water. Do not let conductive liquid such as water enter the battery pack.**
 - If conductive liquid such as water enters the battery pack, short-circuiting occurs, possibly leading to heat generation, fire, or bursting.
- 23. Do not dispose of a used battery pack as household waste.**
 - Failure to follow this instruction may cause a disposed battery pack to be crushed inside a garbage truck and short-circuited, possibly leading to an accident such as fire.
- 24. Do not use this machine at a location where strong static electricity is generated.**
 - Failure to follow this instruction may cause an abnormal action, a liquid leakage, an electric shock, heat generation, smoke, fire, bursting, or other accident.
- 25. Do not use the battery with its polarities (+, -) reversed.**
 - Failure to follow this instruction may cause battery liquid leakage, electric shock, heat generation, smoke, fire, bursting, or other accident.

⚠ WARNING



Prohibition

26. **Do not directly connect the battery pack to the receptacle or a cigar lighter of an automobile.**
 - Failure to follow this instruction may cause battery liquid leakage, electric shock, heat generation, smoke, fire, bursting, or other accident.
27. **Do not heat or highly pressurize the battery back by putting it in a microwave oven or high-pressure vessel.**
 - Failure to follow this instruction may cause battery liquid leakage, electric shock, heat generation, smoke, fire, bursting, or other accident.
28. **Do not use the battery pack for other usages than use on the designated machine.**
 - Failure to follow this instruction may cause battery liquid leakage, electric shock, heat generation, smoke, fire, bursting, or other accident.
29. **When taking out a battery pack, do not put a metal object such as clip, coin, key, screw, or nail close to the battery pack.**
 - Failure to follow this instruction may cause the battery pack to shortcircuit, possibly leading to an electric shock, smoke, fire, bursting, or other accident.
30. **Do not short circuit the terminals of a battery pack.**
 - Carrying or storing a battery pack with a metal object such as a pin may cause short-circuiting, possibly leading to smoke, fire, bursting, or other accident.
31. **Do not put the battery pack in fire.**
 - Failure to follow this instruction may cause the production of harmful substances, smoke, fire, bursting, and other accident.
32. **Do not use a charger that has a broken power plug or cable, has been dropped, or has been damaged.**
 - Failure to follow this instruction may cause an electric shock, heat generation, smoke, fire, or other accident.
33. **Do not use or charge this machine at a location with flammable liquid or gas.**
 - Failure to follow this instruction may cause smoke, fire, explosion, or other accident.
34. **Do not use or charge this machine in the rain or at a humid or wet location.**
 - Failure to follow this instruction may cause an electric shock, heat generation, smoke, fire, bursting, or other accident.
35. **Do not touch the power plug with a wet hand.**
 - Failure to follow this instruction may cause an electric shock.
36. **Do not use this machine when you are tired, drunk, or your ability to move and think is degraded due to treatment drugs or other factors.**
 - Failure to follow this instruction may cause a serious accident or injury.
37. **Do not modify this machine. Do not disassemble or repair it by yourself.**
 - As this machine is compliant with the relevant safety standards, do not modify it.
 - For repair, be sure to consult the store where you purchased this machine or us. Repair of this machine by yourself may lead to an accident or injury.
38. **Do not use or store this machine at a location with a lot of dirt or dust.**
 - Entry of dust or the like in this machine may cause an accident such as heat generation, smoke, and fire.

WARNING



Prohibition

- 39. Do not direct the tip of the riveter to yourself or another person.**
 - Failure to follow this instruction may lead to an injury when a rivet unexpectedly springs out.
- 40. Do not use this machine without attaching the mandrel collector (tank for used mandrel).**
 - Failure to follow this instruction may lead to an accident or injury when the mandrel of a rivet bursts out.
- 41. Do not rivet a rivet with a diameter other than the applicable rivet diameter.**
 - Failure to follow this instruction may cause an accident or injury.
- 42. Do not look into the hole of the nose piece or eject pipe.**
 - The mandrel of a cut rivet may spring out, possibly causing an injury.
- 43. When smoke is generated, do not inhale the smoke.**
 - Failure to follow this instruction may harm your body.
- 44. Do not cover the ventilation hole.**
 - Failure to follow this instruction may cause you to be burned or cause this machine to be abnormally heated, possibly leading to fire.
- 45. Do not allow the hot wind from the ventilation hole to directly blow to your skin.**
 - As the air becomes hot, you may get burned.
- 46. Do not touch a metal part immediately after work.**
 - As the air has become hot, you may get burned.

CAUTION



Compulsory

- 1. Carefully take care of the charger.**
 - Periodically inspect the power cable of the charger, and if it is damaged, request the store where you purchased this machine or us for repair. Failure to follow this instruction may cause an electric shock or short circuit.
 - If you use an extension cord, periodically inspect it, and if it is damaged, replace it with a new one. Failure to follow this instruction may cause an electric shock or short circuit, possibly leading to fire.
- 2. If you do not use the charger, disconnect the power plug of the charger from the receptacle.**
 - This prevents accidents such as electric shock and fire.

⚠ CAUTION

3. Wipe dust and dirt accumulated on the power plug and receptacle with a dry cloth.

- This prevents accidents such as electric shock and fire.

4. When charging is not being carried out, remove the battery pack from the charger.

- This prevents accidents such as electric shock and fire.

5. When disconnecting the power plug, be sure to hold the power plug, not the cord.

- Disconnecting the power plug by holding the cord may cause an electric shock or short circuit.

6. Use an extension cord that suits the usage environment.

- When you charge the battery outdoors, use a cable code or an extension cord of cable code.

7. Pay due attention during work.

- When you use a tool, carefully work while paying due attention to the handling method, work method, and the surrounding situation. An inconsiderate action may cause an accident or injury.
- Use common sense.
Thoughtless action may lead to an accident or injury.
- Do not use this machine when you are tired. Failure to follow this instruction may cause an accident or injury.

8. Check whether there is any damaged part.

- Thoroughly check this machine before use for damage, and check whether this machine normally operates and performs its specific functions.
- Check the movable part for installation condition, parts for damage, and all the other components that affect operation for abnormality.
- If this machine cannot be started or stopped through the operation of the trigger switch, stop using this machine.
Failure to follow this instruction may lead to an accident or injury when an abnormal action is made.

9. When you do not use this machine, adequately store it.

- Store this machine at a dry location that is at a height beyond the reach of children or can be locked with a key. Failure to follow this instruction may cause an accident or injury.

10. Always keep the work site clean and tidy.

- An untidy space or workbench may cause an accident.

11. While lightning is occurring, do not charge the battery, and disconnect the power plug from the receptacle.

- Failure to follow this instruction may lead to a failure, accident, or injury due to lightning strike.

12. Work with appropriate clothing.

- Cover long hair with a cap, hair covering, or the like, and do not wear loose clothes, accessories such as necklaces, and others. Failure to follow this instruction may cause you to be entangled by this machine, possibly leading to an injury.

13. At the time of the first use of this machine after its purchase, if a large amount of rust, damage, abnormal odor, abnormal heat generation, or other abnormality is observed, stop using the machine.

- Consult the store where you purchased this machine or us.
Use of the battery in this condition may cause an accident or injury.



Compulsory

CAUTION



Prohibition

14. When you work at height, confirm that no one is beneath you.

- Failure to follow this instruction may lead to an accident due to the falling of material, this machine, or mandrel of a cut rivet.

15. When the machine body has become hot, suspend work, and after the machine body has cooled down, resume the work.

- Failure to follow this instruction may cause you to get burned.

16. Do not roughly handle the power cable of the charger.

- Do not carry the charger by holding the power cable or pull out the plug from the receptacle by pulling the power cable.
- Do not put the power cable close to heat, oil, or a sharp object.
- Carefully select the charging location so that the power cable is not treaded, hooked, or damaged due to an excessive force. Failure to follow this instruction may lead to an electric shock or fire due to a short circuit.

17. Do not store this machine at a location where the ambient temperature could rise to 50°C or higher (metallic box, automobile in summer, etc.).

- Such an environment may cause deterioration of the machine as well as an electric shock, heat generation, smoke, fire, bursting, or other accident.

18. Do not forcefully use this machine.

- To conduct work safely and efficiently, work at a speed that suits your ability. Use of this machine beyond your ability may cause an accident.
- Do not use this machine in a forceful manner that causes the motor to be locked. Failure to follow this instruction may cause heat generation, smoke, or fire.

19. Do not work in an unnatural posture.

- Always plant your feet on the ground and keep a balanced position. Failure to follow this instruction may cause you to fall, possibly leading to an accident or injury.

20. Do not operate this machine with its frame head dismantled.

- Failure to follow this instruction may cause your finger to be pinched, possibly leading to injury.

21. Do not scatter the mandrels of cut rivets.

- If mandrels are scattered, an accident or injury may occur.

22. Do not allow an LED light to directly irradiate your eyes.

- If an LED light continuously irradiates your eyes, your eyes may be damaged.

23. Do not put children close to this machine. Do not allow other persons than the worker to touch the tool, charger, and power cable.

- Failure to follow this instruction may cause a problem, accident, or injury.

24. Do not use this machine with unnecessary oil or other substances attached.

- Failure to follow this instruction may cause this machine to be dropped, possibly leading to an accident.
- Entry of oil or other substance in this machine may cause an electric shock, smoke, heat generation, fire, or bursting. Wipe off oil and other substances with a dry cloth or the like.

Names of components

Machine body

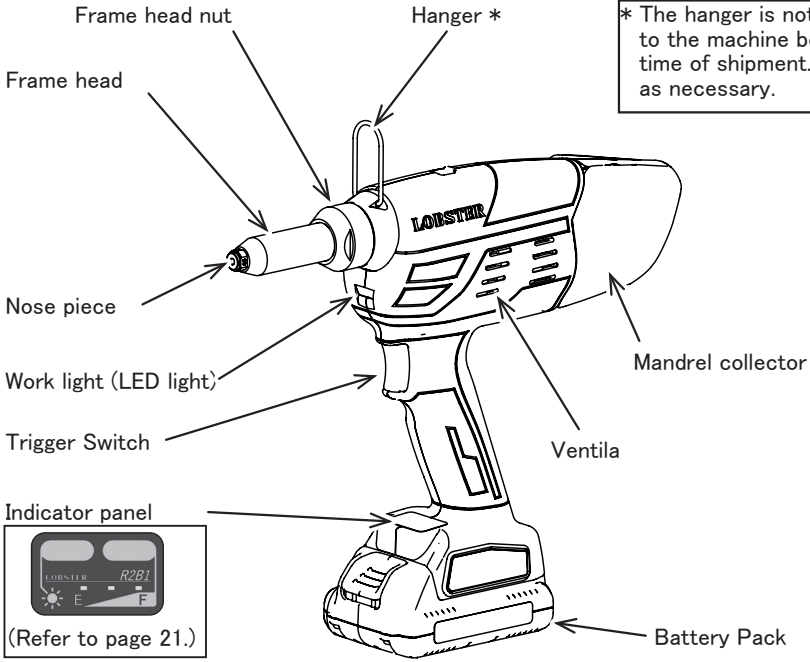

* The hanger is not attached to the machine body at the time of shipment. Attach it as necessary.

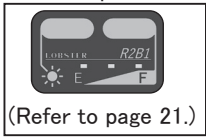

Interior of frame head

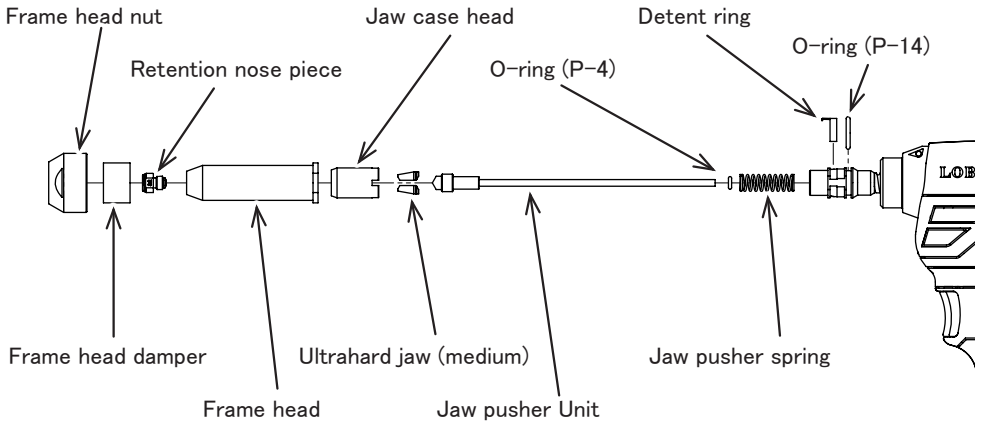

● Battery pack

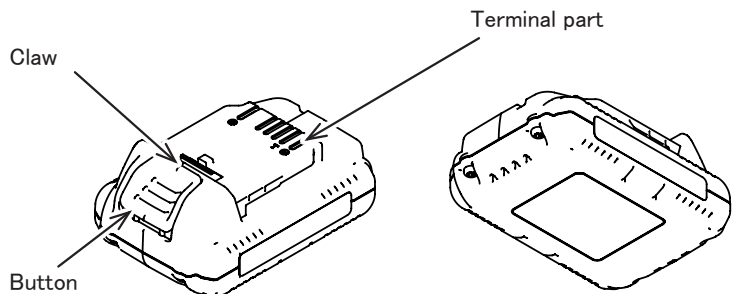

● Charger

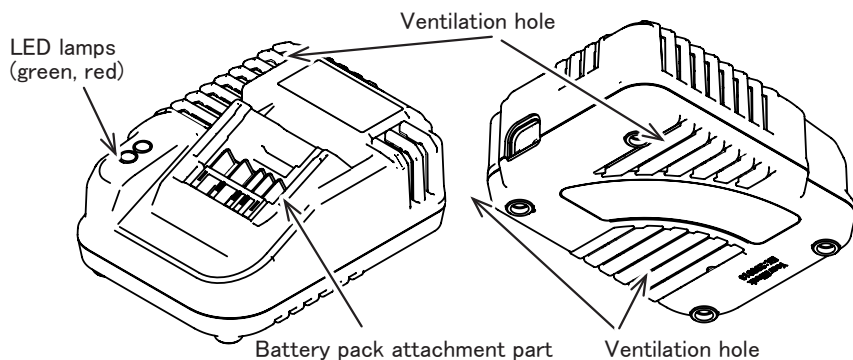

● Power cable

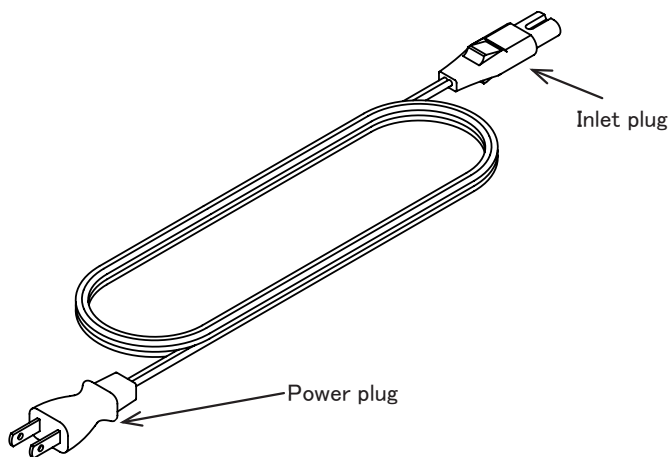

● Specification

Battery capacity		Standard capacity	Large capacity (optional)
Machine body	Model number		R2B1
	Weight		1.7kg 2.0kg
	Power source		18 VDC
	Dimensions		L307 × W76 × H260 mm L307 × W76 × H279 mm
	Tool stroke		25 mm
	Nominal output		10.5 kN
	Applicable rivet diameters		φ 2.4 · 3.2 · 4.0 · 4.8 mm
	Operating environment	Ambient temperature	0°C to 40 °C
	Noise		75 dB (LpA)
	Vibration		2.5 m/sec ² or less
Battery pack	Model number		BPL1825 BPL1850
	Battery		Li-ion rechargeable battery
	Rating voltage		18 V
	Rating capacity		2.5 Ah 5.0 Ah
	Weight		400 g 690 g
	Dimensions		L116 × W76 × H49 mm L116 × W76 × H68 mm
Charger	Model number		BC037T
	Power source		100 to 240 VAC
	Rating charging voltage		20.75 V
	Rating charging current		2.3 A
	Charging time		65 minutes 135 minutes
	Dimensions		L145 × W109 × H70 mm
	Weight		395 g
Operating environment	Ambient temperature	0°C to 40 °C	

- * The specifications and design of the product are subject to change without prior notice.
- * The dimensions, weight, and other amounts are standard values. They may slightly vary depending on the actual product.
- * The location of rating name plate (attachment location of CAUTION/WARNING plates) is the side face at the lower part of the machine body.
- * The serial number is indicated on the bottom of the unit by three-digit alphanumeric characters and five-digit numbers.

How to view manufacturing year

Manufacturing year/month	1	2	3	4	5	6	7	8	9	10	11	12
Code	A	B	M	N	K	W	T	Y	U	O	L	Z

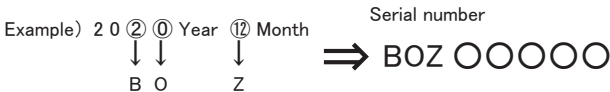

● Preparation before Use

1 Charge the battery pack before using this machine. (Refer to page 16.)

2 Replace the parts (nose piece, jaw pusher unit) in accordance with the size of the blind rivet in use. (Refer to page 22.)

Rivet size (rivet diameter) [mm]	Marking on nose piece and jaw pusher unit
φ 2.4	2.4
φ 3.2	3.2
φ 4.0	4.0
φ 4.8	4.8

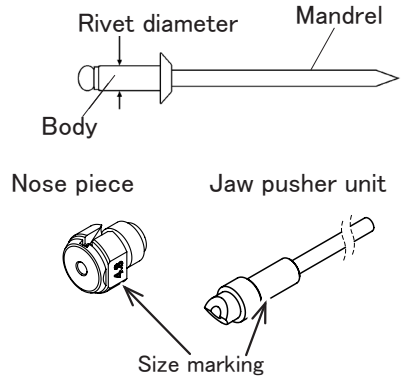

It is possible to use standard blind rivets in various sizes only by replacing the nose piece and jaw pusher unit.

The product comes with the nose piece and jaw pusher unit for φ 4.8 size at the time of purchase.

⚠ CAUTION

Do not work with the wrong combination of parts even when a blind rivet can be inserted. Failure to follow this instruction may cause a failure or accident.

3 Check for foreign objects in the mandrel collector. While pushing down the lever of the mandrel collector ①, turn it down and remove it ②. Then, make sure that nothing is in the mandrel collector.

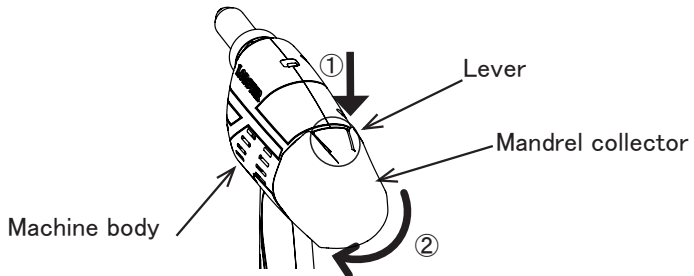

⚠ CAUTION

If the mandrel collector is used with some foreign object left in it, the discharge of mandrel may be obstructed, which may cause the riveter to fail.

- 4** Mount the mandrel collector. Positively mount the mandrel collector until the claw is engaged with the machine body with a clicking sound.

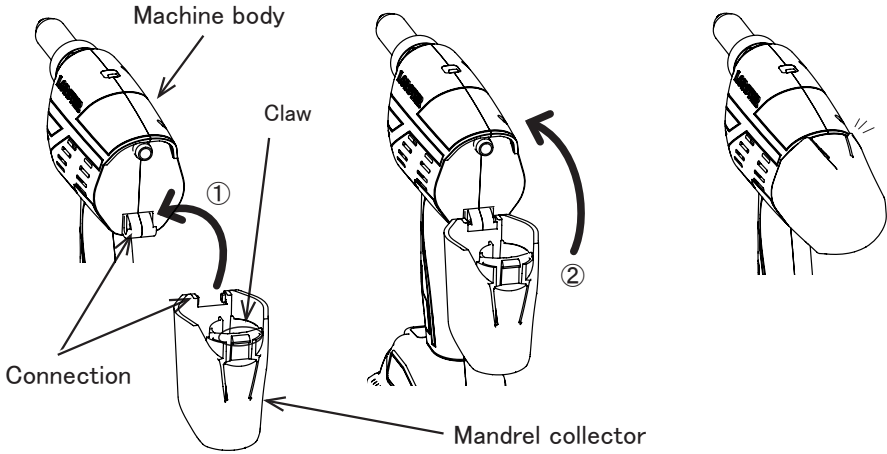

⚠ CAUTION

For safety, this machine is designed to operate only when the mandrel collector is mounted. If the mandrel collector is broken, replace it with a new one. If used with damaged, the mandrel of the cut blind rivet may suddenly pop out and cause an accident or injury.

- 5** Attach the battery pack.
Positively attach the battery pack until the claw is engaged with the machine body with a clicking sound.

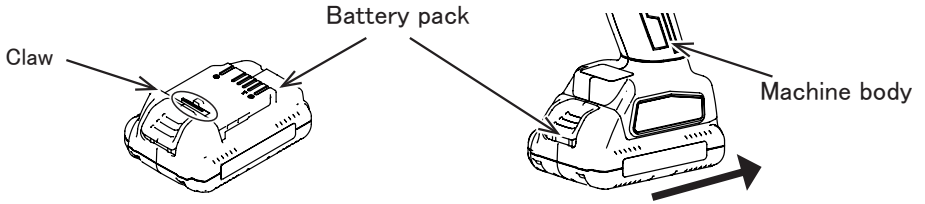

⚠ CAUTION

Attach the battery pack without touching the movable parts because any of the movable parts may suddenly start moving if it is touched.

- 6** Before starting the riveting operation, pull the trigger switch and check that it works properly.
If you can confirm, preparation before use is completed.

● Procedures for charging

For charging of the battery, be sure to use the dedicated charger.

- 1** Connect the power cable to the charger ① and insert the power plug into a receptacle ②. When the charger is energized, the green LED lamp slowly blinks.

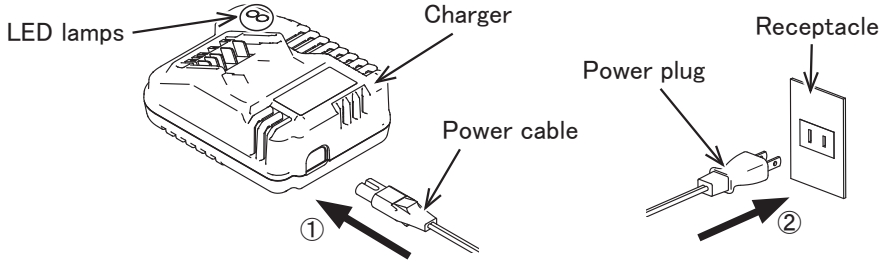

⚠ CAUTION

This charger can be used with AC 100V to 240V.
Do not use the charger by connecting it to a DC power source or an engine power generator.

- 2** Positively insert the battery pack all the way to the back of the charger. When the battery pack is inserted to the back, the lighting condition of the LED lamps changes. The contents of indications of the LED lamps are as shown in the following table.

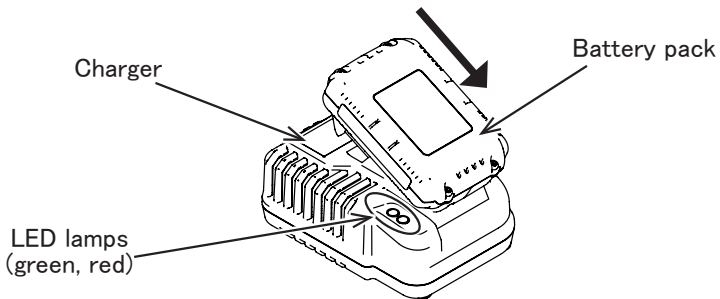

LED lamp lighting condition		Contents of indication
Red	Green	
–	Blinking (low speed)	Standby for charging (charger is energized)
Lit	–	Charging in progress
–	Blinking (high speed)	Completion of practical charging (completion of 80% charging, full charging in progress)
–	Lit	Full charging completed (charging completed)
Blinking (low speed)	–	Charging is suspended due to a temperature out of appropriate temperature range
Lit	Lit	Charging disabled (abnormal state)

⚠ CAUTION

When the temperature of the battery pack is high or low, it will not be charged to protect the battery pack. When the temperature of the battery pack enters the appropriate range, charging starts.
Charge the battery in the ambient temperature range of 0 to 40°C .

- 3** When the charging is completed, remove the battery pack from the charger, and disconnect the power plug from the receptacle.

Number of fasteners

This is the number of units that can be tightened continuously when the battery pack is fully charged. [pcs.]

Rivet body diameter	Battery pack 2.5 Ah (typical)	Battery pack 5.0Ah (Optional)
φ 2.4	1700	3400
φ 3.2	1500	3000
φ 4.0	1200	2400
φ 4.8	1100	2200

The number of fasteners is approximate.
It varies depending on the rivet used, the base material specification, and the condition of the battery pack.

● Work procedures

● Riveting work

⚠ WARNING

- Never look into the hole of the nose piece. Otherwise, you may get injured when a cut mandrel springs out.
- Note that when you work with this machine oriented downward, cut mandrels may be discharged from the nose piece.
- If you observe any abnormality such as abnormal sound, abnormal odor, and smoke, immediately remove the battery pack from the machine body.
If you cannot identify the cause of an abnormality, contact us or request us for repair.

<Operating temperature>

Use this machine in the ambient temperature range of 0°C to 40°C.

1 Select blind rivets with a size that suits the thickness of the base material to be riveted.

2 Replace the nose piece and jaw pusher unit to fit the blind rivet size.
(Refer to Step **2** in “Preparation before Use” on page13.)

3 Open the correct hole (ϕ 0.1 to 0.2mm larger than the rivet diameter) in the base metal to be riveted.

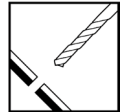

4 Insert the mandrel of the blind rivet into the tip of the riveter.



⚠ CAUTION

The tip of the mandrel of some blind rivet may be sharp.
Pay attention not to have your finger injured.

5 Insert the blind rivet body into the pilot hole.

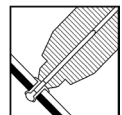

6 Lightly press the tip of the riveter against the base material, and after confirming that there is no clearance from the base material and other object, pull the trigger switch.

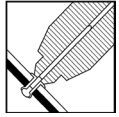

7 The body of the blind rivet is riveted to the base material.



8 Tilt the riveter backwards, release the trigger switch, and discharge the cut mandrel to the mandrel collector or to the outside.

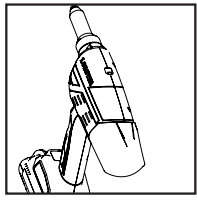

⚠ CAUTION

Move on to the next riveting after the mandrel is reliably ejected.
If mandrels remain on the top of the mandrel collector, shake the riveter gently to drop it to the bottom.

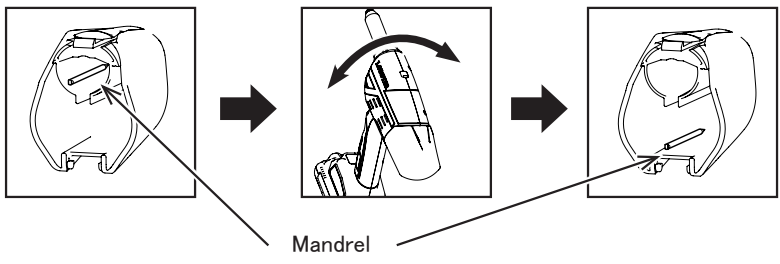

The cut mandrel may protrude from the nose piece tip, but this is not a malfunction.

Remove the protruding mandrel and continue the work.

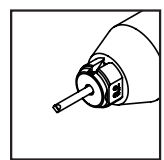

- 9** If about half of the capacity of the mandrel collector is filled with mandrels, remove the mandrel collector and dispose of the mandrels contained in it. (Refer to Steps **3** and **4** in “Preparation before Use” on page 13–14.)

⚠ CAUTION

If mandrels are excessively accumulated in the collector, the discharge of mandrels is obstructed, which may lead to a reverse flow or a failure of the riveter. Dispose of the mandrels in the mandrel collector little by little as much as possible.

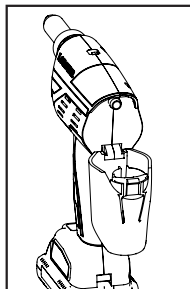

Approximate Collector Capacity

Rivet body diameter	Capacity [pcs.]	Disposal guideline [pcs.]
φ 2.4	700	350
φ 3.2	450	250
φ 4.0	230	150
φ 4.8	200	100

- ※ Capacity is approximate.
It varies depending on the mandrel diameter and length of the rivet used.

<When you want to eject the mandrel forward>

If you wish to eject the mandrel forward after riveting, use the nosepiece of the “Parts List Option (Refer to P.29)” and riveting. Then, move the machine to the position where you want to eject while pulling the trigger switch and release the trigger switch.

● Indication of remaining battery power

- 1** When the riveter is activated, the current battery level is indicated by the illumination of the LED lamp as shown in the table below.
If you press the button on the right side of the battery indicator panel at the bottom of the unit within 8 seconds after the LED lamp turns off, the remaining battery power is represented by the LED lamp turning on again.

Remaining battery power indication button

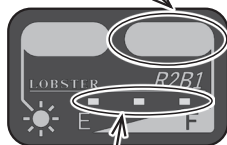

LED lamp x 3

Number of fasteners
(reference)
(Refer to page 17.)

LED lamp lighting condition			Contents of indication
Left	Center	Right	
Lit	Lit	Lit	Remaining battery power of 100 to 70%
Lit	Lit	–	Remaining battery power of 70 to 30%
Lit	–	–	Remaining battery power of below 30%
Blinking	–	–	No battery power remaining *1
–	–	–	Battery pack unattached *2
Blinking	–	Blinking	Safety device activation *1

*1 Charge the battery.

*2 Wear the battery.

*3 Check the mounting of the mandrel collector.

- 2** The LED lamps light out 2 seconds after the lamps light.

● Lighting of work light (LED light)

- 1** When the riveter is operated, the work light installed at the lower part of the frame head lights, and then it goes off when 10 seconds have passed since operation stop.

- 2** When you press the button on the left side of the indicator panel located at the lower part of the machine body, the lit/unlit condition of the light during riveter operation can be switched.

Work light
switching button

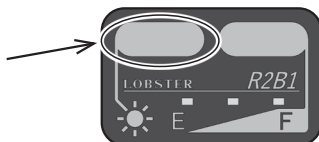

● Points of Maintenance and Inspection

● Cleaning of interior of frame head

* Also refer to this section for replacement of replacement parts.

When riveting has been performed for long hours, mandrel chips and dirt get accumulated in components, possibly causing a problem. Periodically clean the components by following the instructions in this document.

When chips are accumulated, the smoothness of the jaw is lost, and it becomes impossible to work normally. Clean this machine once in riveting of 2,000 rivets as a guide.

⚠ CAUTION

When disassembling this machine for servicing, part replacement, and other purposes, be sure to remove the battery pack. When servicing or disassembly is performed with the electric power supplied, parts may spring out or an electric shock, unexpected movement, or the like may occur, possibly causing an accident or injury.

Do not operate this machine with the frame head dismounted. Failure to follow this instruction may cause an injury such as pinching of fingers.

- 1 Remove the battery pack from the machine body. While pressing down the button (①), slide the battery pack (②).

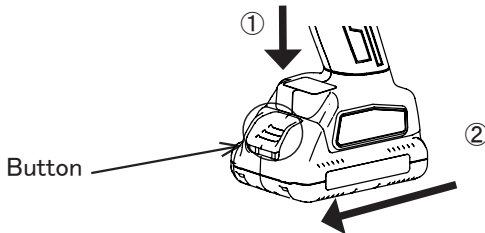

- 2 Remove the frame head nut (right-hand thread) by loosening it (1), and then remove the frame head (2).

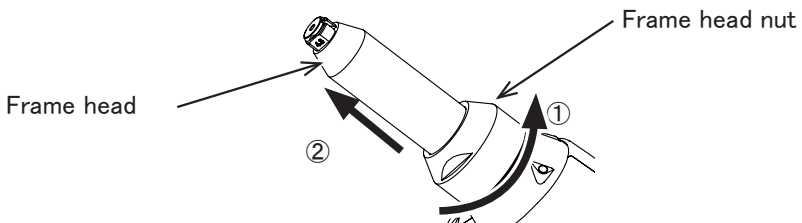

- 3** Slide the detent ring until it contacts the rear (①), loosen and remove the jaw case head (② right screw).

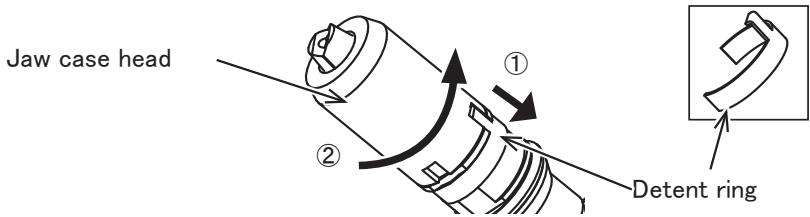

⚠ CAUTION

The jaw case head can be loosened only by sliding without removing the detent ring.

- 4** Remove the jaw, jaw pusher unit, jaw pusher spring, and O-ring.

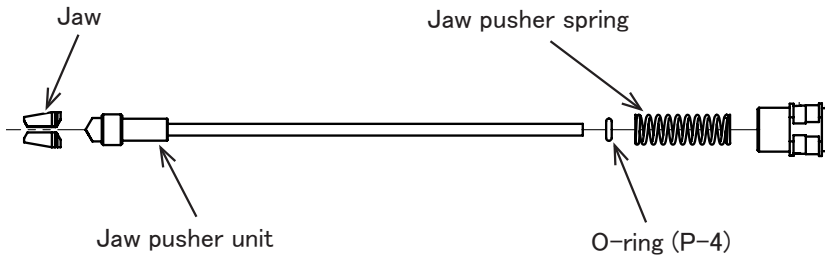

⚠ CAUTION

The jaw, jaw pusher unit, jaw pusher spring, O-ring, jaw case head, and nose piece are parts that need to be periodically replaced. Replace such parts that are damaged or broken.

When replacing the nosepiece, hook a wrench or other tool on the two chamfers of the nosepiece and the end of the frame head (right-hand thread).

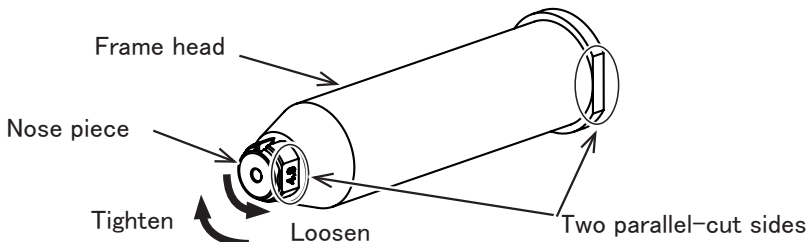

Cleaning

- 5 Clean the removed parts with a brush or the like. Be sure to clean the jaw, frame head inner side, and jaw case head inner side in particular, as they are apt to collect dust.

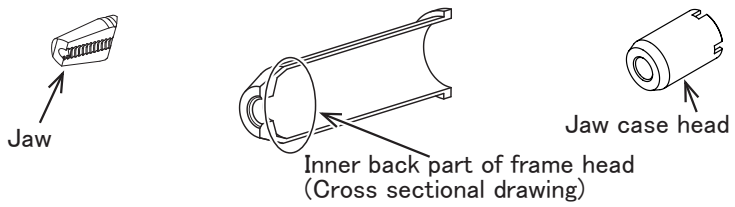

- 6 Apply lubricant to the back of the jaw (cone surface) or the interior of the jaw case head (cone surface), and then insert the jaw to the jaw case head.

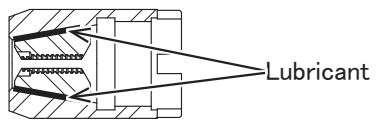

CAUTION

Apply LOBSTER brand lubricant oil JO50 (separately sold, containing molybdenum disulfide grease) to the back of the jaw (cone surface) or the interior of the jaw case head (cone surface).

- 7 After attaching the O-ring (P-4) to the jaw pusher unit, insert the jaw pusher spring and the jaw pusher unit into the inside of the jaw case in this order.

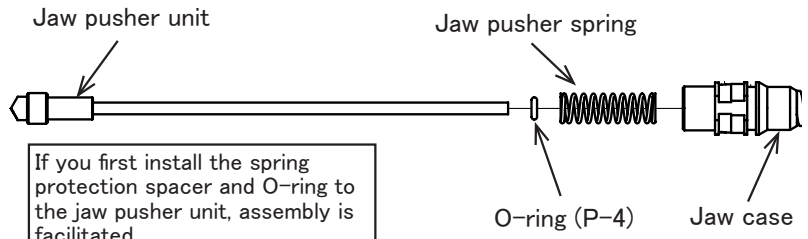

If you first install the spring protection spacer and O-ring to the jaw pusher unit, assembly is facilitated.

CAUTION

Do not forget to attach the O-ring (P-4).

Assembly

- 8** Fully tighten the jaw case head (right-handed screw) ①, and then return the jaw case head to the point where the notches are aligned first with each other ②. Insert the detent ring by sliding it into the cutout part (③). Confirm that the jaw case head no longer freely rotates.

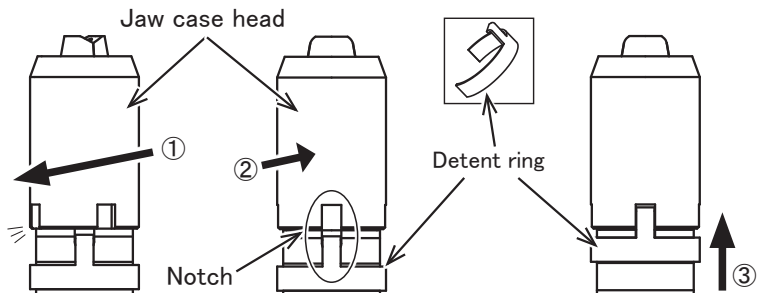

⚠ CAUTION

If the jaw case head freely rotates, it may be loosened or broken during use of this machine.

- 9** Install the frame head, frame head damper, and frame head nut in this order to the machine body and secure the parts by tightening the frame head nut (right-hand thread).

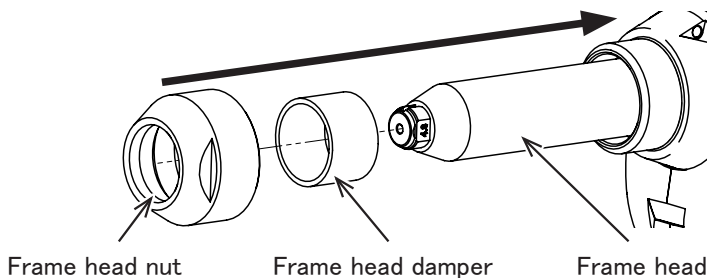

⚠ CAUTION

Apply lubricating oil or the like to the threads to prevent the frame head nut from galling.

- 10** When all the parts have been assembled, confirm that this machine operates normally. When you have checked the operation, the cleaning of the interior of the frame head is completed.

● Cleaning the Nosepiece

If the holding is weak or impossible even after inserting the rivet, clean and lubricate the steel ball hole and the steel ball of the nosepiece.

⚠ CAUTION

The parts are small. Be careful not to lose them.

Clean the steel ball hole and the steel balls with the nosepiece attached to the frame head. If force is applied to the steel ball when it is not attached to the frame head, the steel ball may pop out.

- 1** Remove the nosepiece with frame head from the tool.
Clean the 2 holes for steel ball and rivet mandrel by air blow.

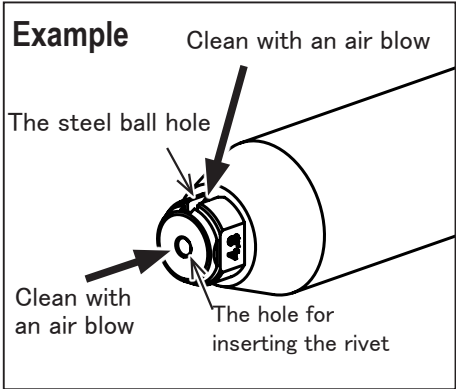
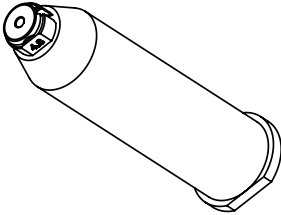

- 2** After cleaning, apply a low-viscosity lubricant to the steel ball hole and reassemble. Wipe off the overflowing lubricating oil.

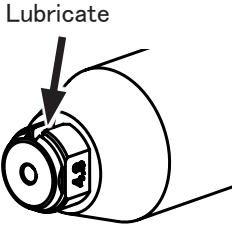

⚠ CAUTION

If the problem is not improved by cleaning, replace the nosepiece itself.

● Inspection of charger

Disconnect the power plug from the receptacle and check the power cable for damage and the terminal part for dirt and other attachments.

● Cleaning

Wipe the machine body, battery pack, and charger with a soft cloth.

Use of organic solvent such as thinner and benzine may cause defects such as deformation, discoloration, or cracks.

● Service life of battery pack

The battery pack has a service life. When the number of rivets that can be riveted has decreased even after the battery is charged, the battery pack has reached the end of its service life.

Replace the battery pack with a new one.

WARNING

Never use a battery pack other than ones designated by us or a modified battery pack (including such a battery pack whose storage battery or other part has been replaced). We assume no responsibility whatsoever for any accident and failure caused when a prohibited battery pack is used.

• < About recycling >

- The lithium ion battery used in this product is a recyclable battery pack.
- For the purpose of recycling of precious resources and the preservation of the environment, please carry unnecessary or used battery packs to the store where you purchased the product. (At the terminal part of a battery pack, be sure to attach insulation tape or the like to prevent short-circuiting.)
- When disposing of tools, observe the laws, regulations, and ordinances of the country or autonomous body concerning waste.



● Storage method

After using this machine, store it at a dry location beyond the reach of children.

If you are not going to use this machine for a long time, remove the battery pack from the machine body. If you are not going to use this machine for a long time (six months or longer), store it at a location where the ambient temperature is 35°C or below.

To prevent over-discharge of the battery pack, periodically charge the battery up to the charging capacity for practical use. Do not store the battery pack while being attached on the machine body or charger.

● Parts table

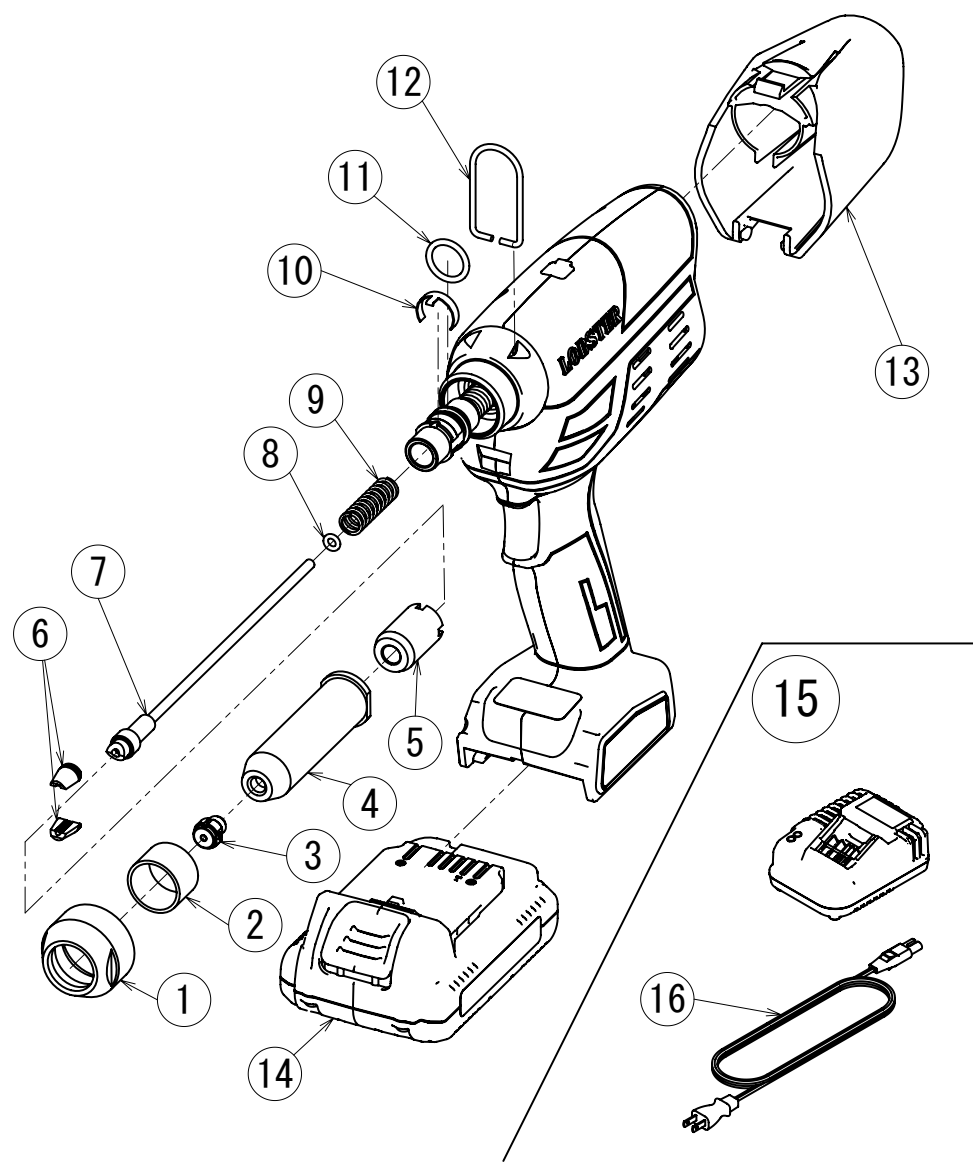

No.	Part name	Code No.	Consumable parts	Material
1	Frame head nut	68425		aluminum
2	Frame head damper	68449	○	rubber
3	Retention nose piece Unit 4.8 *	71360	○	steel
(3)	Retention nose piece Unit 2.4	71357	○	steel
(3)	Retention nose piece Unit 3.2	71358	○	steel
(3)	Retention nose piece Unit 4.0	71359	○	steel
4	Frame head	68448		steel
5	Jaw case head	10280	○	steel
6	Ultrahard jaw(medium)	10281	○	steel
7	Jaw Pusher 4.8 Unit *	68436	○	①
(7)	Jaw Pusher 2.4 Unit	68439	○	①
(7)	Jaw Pusher 3.2 Unit	68438	○	①
(7)	Jaw Pusher 4.0 Unit	68437	○	①
8	O-ring P-4	10454	○	rubber
9	Jaw pusher spring	68441	○	steel
10	Detent ring	68428		steel
11	O-ring P-15	10405	○	rubber
12	Hanger	68424		steel
13	Mandrel collector	68445	○	plastic
14	Battery pack BPL1825	474	○	②

- Parts marked with * are assembled at the time of shipment.
- Part numbers marked with parentheses are accessories.
- The hanger is not assembled at shipment.
- Parts marked with an O mark on the consumables item are those that require periodic replacement.
- Material ① contains steel and stainless steel.
- The material ② is a lithium-ion battery. Recycle the product in accordance with laws and regulations.
- The nose pice listed in the optional parts list does not have a rivet holding movhanism.

Optional accessories

	Nose piece 2.4	10027	○	steel
	Nose piece 3.2	10028	○	steel
	Nose piece 4.0	10029	○	steel
	Nose piece 4.8	10030	○	steel
	Large capacity battery pack BPL1850	476	○	②

Charger

15	Charger BC037T(for 120V)	9787	○	Electronic device
	Charger BC037T(for 230V)	9791		
16	Power cable (for 120V)	68759	○	③
	Power cable (for 230V)	68760		

- A power cable is included with the BC037T.
- Material ③ contains copper,plastic and rubber.

● How to Order Parts

Order parts by explicitly specifying the model name, part name, code No., and quantity as shown below.

(Example)

Model name	Part name	Code No.	Quantity
R2B1	Ultrahard jaw (medium)	10281	1 set
R2B1	Jaw Pusher 4.8 Unit	68436	1 piece

⚠ CAUTION

Note that when a part has been improved, the holding period of the old part is five years.

● Troubleshooting

Before judging whether a given phenomenon is a failure, check the following items. If the phenomenon does not correspond to any of the following, contact us or request us for repair.

When making an inquiry or request for repair, we would appreciate if you could check the following items and notify us of the use condition, phenomenon, and other information in detail because doing so may help to shorten the time required for repair and delivery.

Phenomenon	Cause	Corrective action
A rivet cannot be inserted in this machine. Or the mandrel cannot be removed after riveting.	A wrong nose piece or jaw pusher is selected.	Replace with a correct part that suits the rivet size. (Refer to page 13.)
	Nose piece is loosened.	Completely tighten the nose piece with a spanner or the like. (Refer to page 23.)
	Assembly of the jaw case part is inappropriate.	Check the installation order of the parts inside the jaw case.
	The smoothness of the contact surface between the jaw and the jaw case head is insufficient (bite).	Clean the interior of the jaw and jaw case and apply LOBSTER brand lubricant to the back of the jaw. (Refer to page 22 to 25.)
	Mandrels are stacked or jammed in the jaw case or jaw pusher unit.	Remove the jaw case head and remove mandrels that are jammed in the jaw case and jaw pusher unit.

Phenomenon	Cause	Corrective action
The mandrel collapses in the frame head.	Forgetting to release mandrels.	Discharge the mandrel to the mandrel collector before performing the following operations.
A rivet cannot be cut in a single operation.	The rivet is not suitable for the thickness of the plate in use.	Use a rivet suitable for the plate thickness.
	Assembly of the jaw case part is inappropriate.	Check the installation order of the parts inside the jaw case.
	The Jaw is worn.	Replace the jaw.
	Insufficient jaw lubrication.	Clean the inside of the jaw and jaw case head, and apply shrimp lubricant to the back of the jaw. (Refer to page 22–25.)
The motor does not start up.	The battery pack is not charged.	Charge the battery pack.
	Dirt is attached at the contact point between the battery pack and machine body.	Remove the dirt.
	The protection circuit of the battery pack has started up due to an overload.	Remove the cause of the overload.
	The mandrel collector is disconnected.	Mount the mandrel collector.
The work light does not light.	The work light is set to disabled.	Change the setting by using the work light setting button. (Refer to page 21.)
The operation time of the battery pack is very short even after it has been charged correctly.	The battery pack has reached the end of its service life.	Purchase a new battery pack.
When a fully charged battery pack is charged again, the charging lamp lights.	This occurs because it takes a while to detect the fully charged condition.	In a short while, the charging complete indication appears.
Noise interference on a TV or radio during charging.	This occurs because charging is controlled by using high frequency waves.	Charge this machine by using another receptacle. Keep this machine away from the radio or TV set.

Phenomenon	Cause	Corrective action
The charging lamp does not light even when the battery pack is inserted to the charger.	The power cable is not connected.	Connect the power cable to a receptacle.
	Dirt is attached at the contact point between the charger and the battery pack.	Remove the dirt. Work with the power plug disconnected.
It takes time to complete charging.	The battery pack is heated (orange lamp blinks, indicating the charging standby state).	Perform charging after the battery pack has been cooled down.
	The battery pack is cold.	Leave the battery pack in an environment at a temperature of 10°C or higher for about one hour, and then perform charging.
The mandrel collector opens.	The mandrel is too loose in the mandrel collector.	Dispose of the mandrel regularly. (Refer to page 20.)
The cut mandrel protrudes from the nose piece tip.	The broken surface of the rivet is sharp.	Remove the protruding mandrel and continue the work.
Holding of the rivet is weak or impossible.	Insufficient nosepiece cleaning.	Clean the nosepiece. (Refer to P.26.)

MEMO

.....

.....

.....

.....

.....

.....

.....

.....

.....

.....

.....

.....

.....

.....

.....

.....

.....

.....

.....

.....

.....

.....

.....

.....

MEMO

.....

.....

.....

.....

.....

.....

.....

.....

.....

.....

.....

.....

.....

.....

.....

.....

.....

.....

.....

.....

.....

.....

